

WFR50 AC WIFI Receiver

SPECIFICATION and INSTRUCTION SHEET

ELECTRICAL SPECS: 120 Volts, 60 Hertz, Fan 1.0 amp

FAN MODEL USED: May be used in conjunction with TR500 Remote Control.

Compatible with most Fanimation AC motor fans - see catalog or visit our website, www.FANIMATION.com for more information

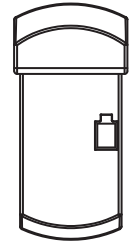

NOTE: If fan or supply wires are different colors than indicated, have this unit installed by a qualified electrician.

WARNING

To avoid possible electrical shock, be sure electricity is turned off at the main fuse box before wiring. **NOTE:** If you are not sure if the outlet box is grounded, contact a licensed electrician for advise, as it must be grounded for safe operation.

INSTALLATION INSTRUCTIONS:

1. Dip Switch Set Up

NOTE: The remote unit has 32 different code combinations. To prevent possible interference from or to other remote units, simply change the combination code in the remote and receiver.

NOTE: Factory setting is all up. Do not use this position.

- To set the code on receiver unit, slide dip switches to the same positions as set on the remote, if using in conjunction with the TR500 remote (Figure 1)

2. The breaker and wall switch that controls the power to the fan must be in the off position. Please make sure that the wall switch that controls the power to the fan and ligh kit if installed, is a true on off toggle or rocker switch. It cannot have a dimming function on of any kind.

3. Install Receiver in the Hanger Bracket:

- Slide remote Receiver into the Hanger Bracket (Figure 2).
- Connect wires as indicated: (Figure 3)
 - BLACK Receiver Unit wire (AC IN L) to BLACK supply wire.
 - WHITE Receiver Unit wire (AC IN N) to WHITE supply wire.
 - WHITE Receiver Unit wire (TO MOTOR N) to WHITE fan wire.
 - BLACK Receiver Unit wire (TO MOTOR L) to BLACK fan wire.
 - BLUE Receiver Unit wire (FOR LIGHT DOWN) to BLUE light wire.
- Position all connected wires and receiver antenna to allow installation of ceiling canopy.

4. The receiver has a wifi antenna that can be used if you experience range issues. (Figure 4)

5. Restore electrical power at the breaker and wall switch.

6. Ceiling fan must be set at HIGH speed and light kit (If any) at the ON position by pressing the "Light Switch" after installation.

7. Follow the app set up instructions on the following pages.

WARNING: To avoid possible fire or shock, make sure that the electrical wires are completely inside the outlet box and not pinched between the wall plate and the wall.

WARNING: Check to see that all connections are tight, including ground, and that no bare wire is visible at the wire connectors, except for the ground wire. Do not operate fan unless blades are in place. Noise and fan damage could result.

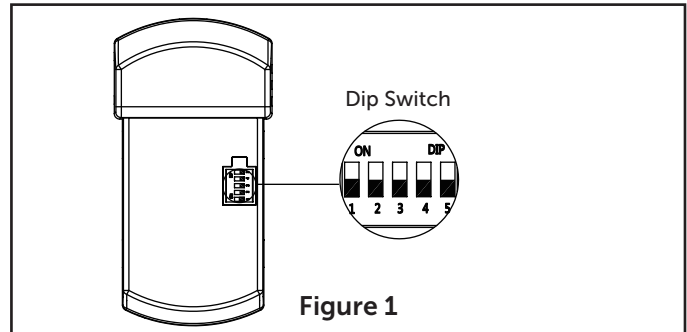

Figure 1

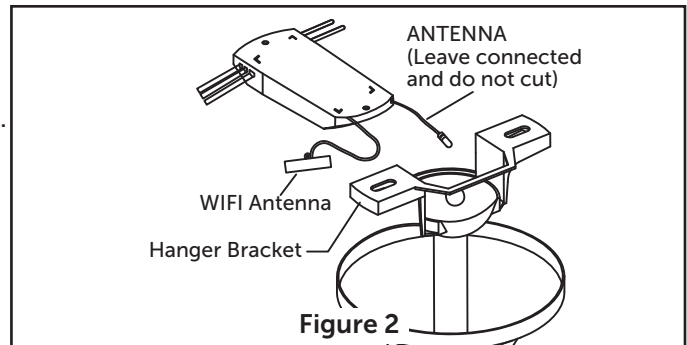

Figure 2

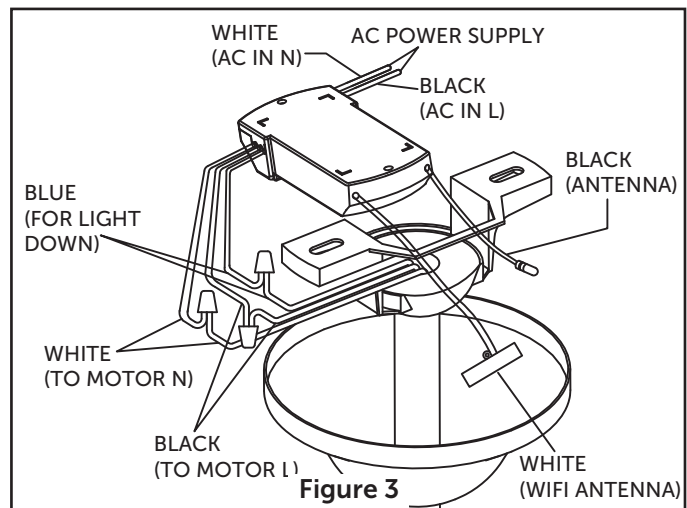

Figure 3

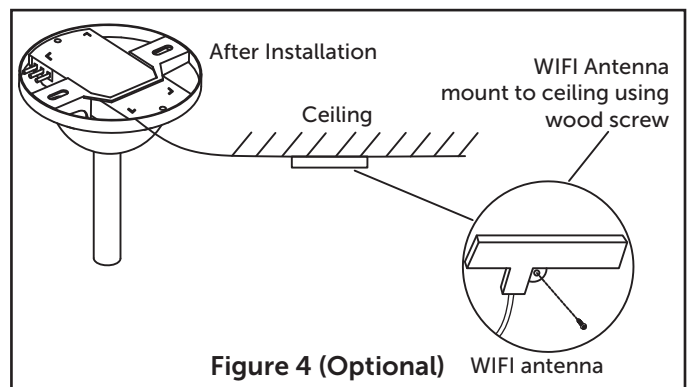
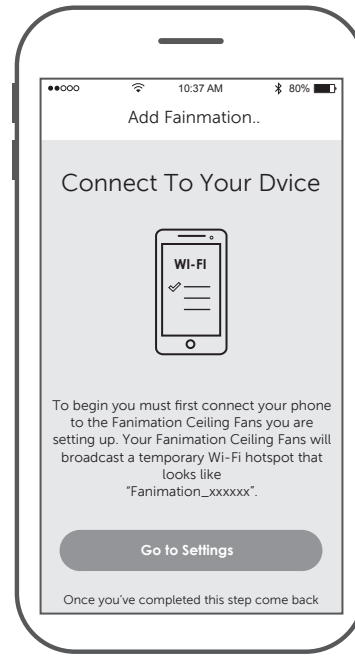
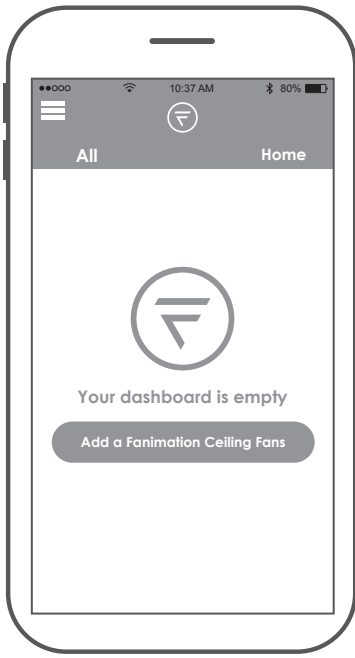

Figure 4 (Optional) WIFI antenna

fanSync WiFi APP Setup

1. Visit the Apple APP Store or the Google Play Store to download the free fanSync WiFi APP.
2. Create your Fanimation fanSync account.
3. At this stage, your ceiling fan Wi-Fi receiver should be installed and within range of your Wi-Fi router.
4. With the APP open, select "add device".



NOTE: The device default Wi-Fi SSID : Fanimation_XXXXXX (ex: Fanimation_402AD4).

5. Select the Fanimation_XXXXXX device.

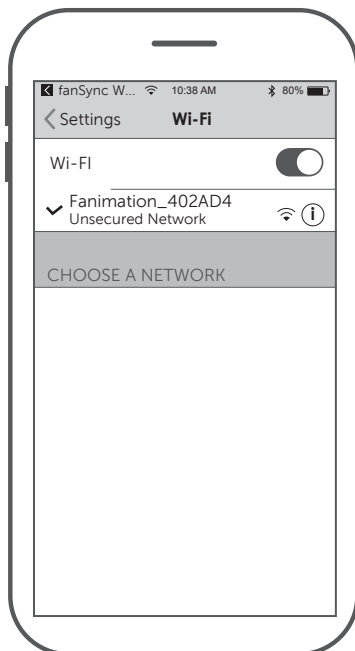

6. Press "CONTINUE".

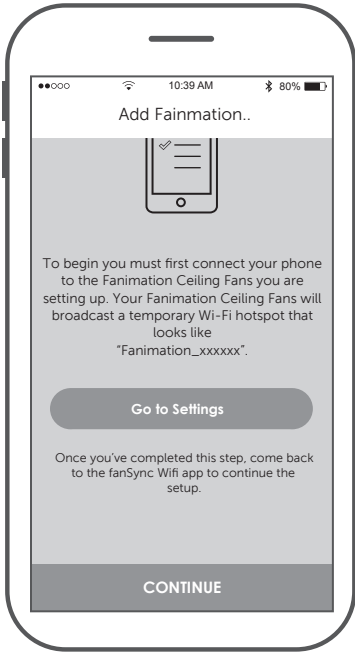

- 7. Select your WiFi router and enter the WiFi password to connect your fanSync WiFi receiver. It will take 1-2 minutes to connect.
- 8. After your WiFi receiver is connected, you can now name your ceiling fan in the APP and customize your settings.

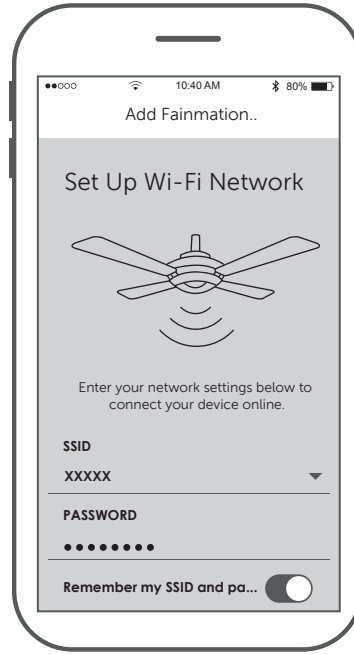

• fanSync WiFi APP Overview

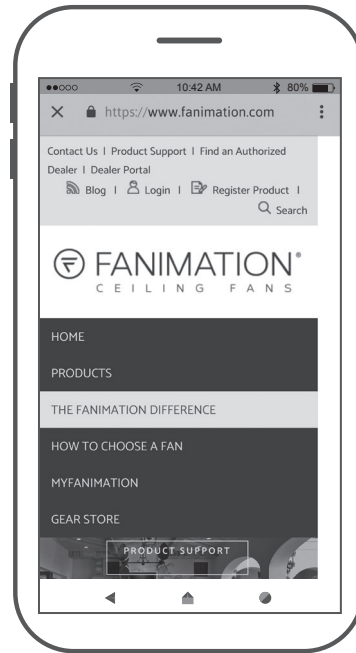
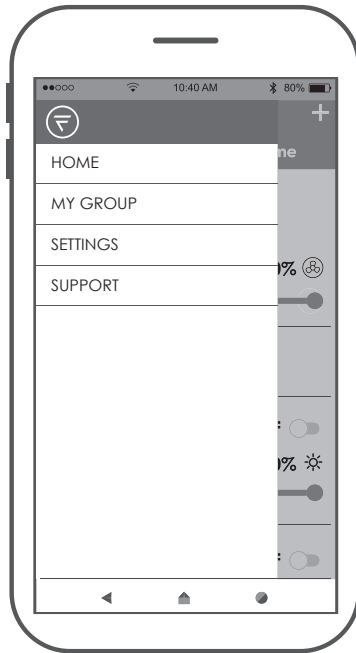
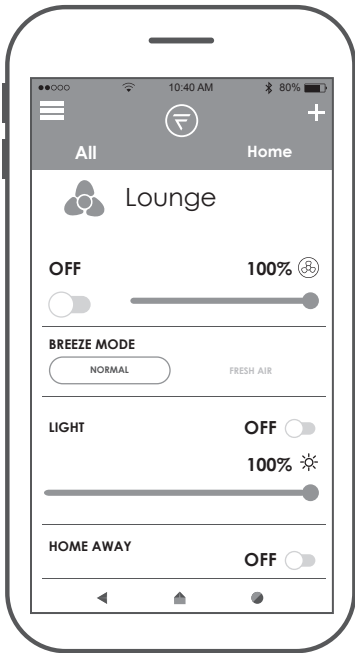

- Set up Real Time Schedule

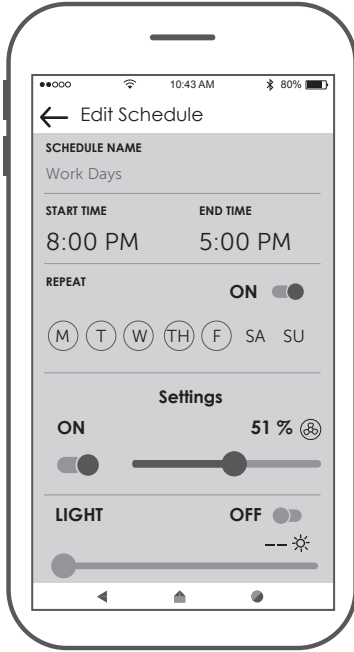

- Share Device

After one smart device is connected to a fan, that in order for other APP users to control the fan that you must share the device with other users.

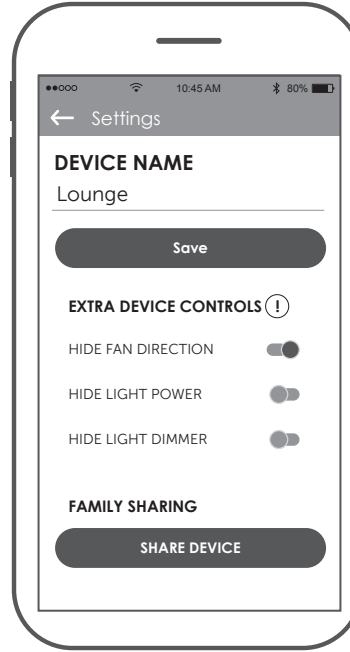

- Link with Amazon Echo, Google Home and IFTTT

Select the device you want to connect and follow the instructions in the set up procedure.

Amazon Alexa Help: <https://www.amazon.com/gp/help/customer/display.html?nodeId=201749240>

In order to connect with NEST, ECOBEE, Samsung Smart things, wink, etc. that you must connect via IFTTT.

IFTTT Help: <https://help.ifttt.com/hc/en-us/articles/115010325748-What-is-IFTTT->

Google Help : <https://support.google.com/googlehome/answer/7073578?hl=en>

